

8 7 6 5 4 3 2 1

D

D

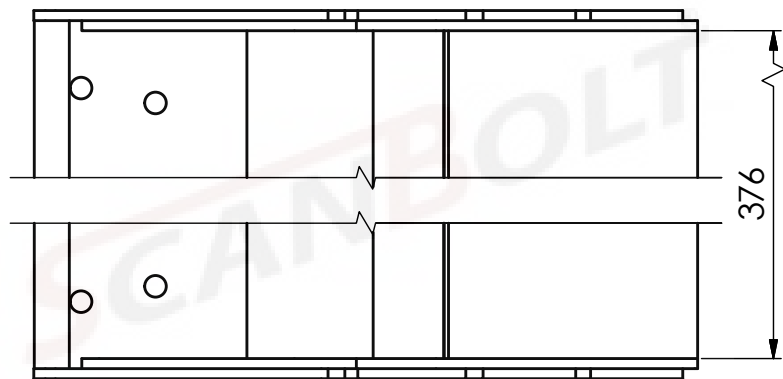
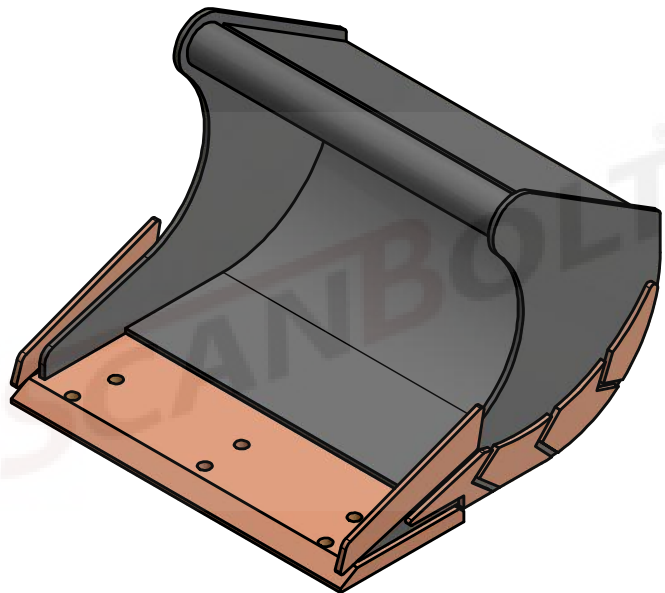

C

C

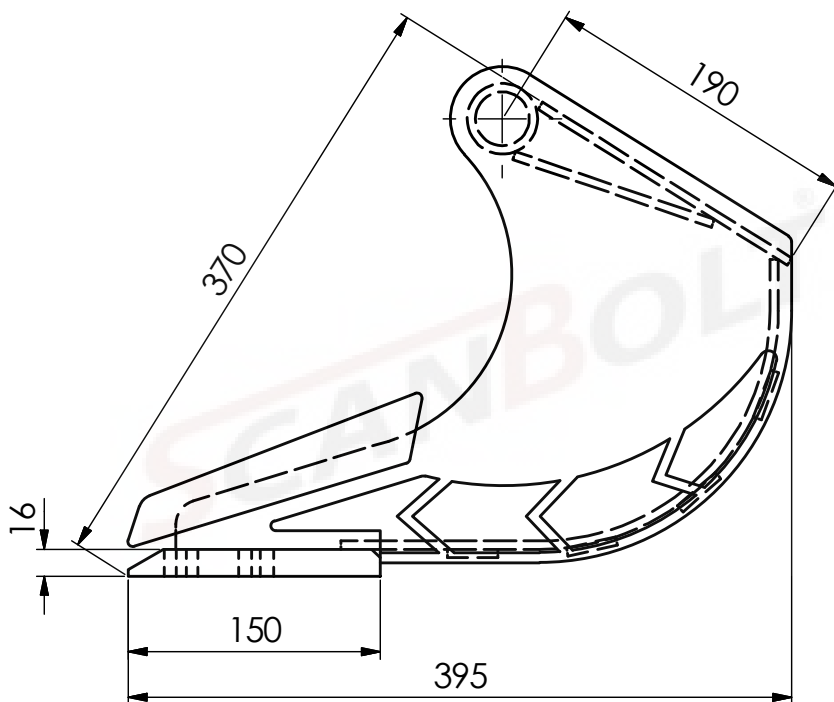
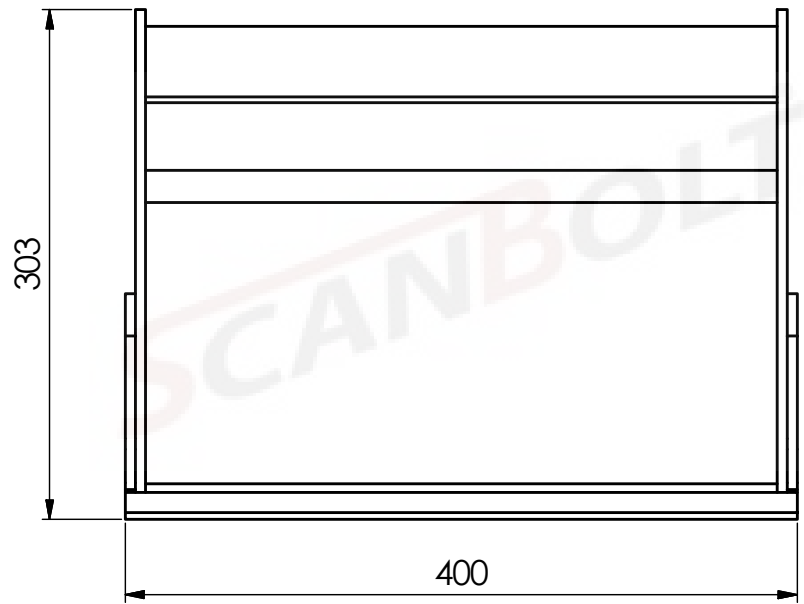





B

B

A

A

MATERIAL SPECIFICATION	
	ST52.3
	EN8D
	HB 400
	HB 450
	CASTALLOY STEEL

SCANBOLT®	
DESCRIPTION	40CM DIGGING BUCKET
MACHINE CLASS	0.5-1.2 TON
WEIGHT	27.6 Kg
HEAPED CAPACITY	28.6 LITERS

8 7 6 5 4 3 2 1